

# ahmarra

Fire Door Manufacture & Installation



## HEALTHCARE DOOR RANGE

Version 1.5 | 02-06-2026

Timber  
Fire Door  
Manufacture



Fire Door  
Installation



Ahmarra specialise in manufacturing and installing Q-Mark certified fire doors for healthcare facilities such as hospitals, healthcare centres and care homes. Engineered for longevity, the Healthcare Door Range has been specifically developed to suit the demands of busy healthcare environments.

We work closely with architects, contractors, building surveyors and fire safety officers to understand the unique requirements of their project. From site survey and design to manufacture and installation, we can fully project manage your internal doorset and glazed screen packages.

### Why Choose Ahmarra?

- **360° Confidence** - providing high quality service - from early design, Fire Door CPD, VE toolbox talks, innovation, in-house ironmongery expertise, bespoke manufacture, installation and after sales technical support
- **Bespoke** - manufactured to suit your new or existing openings utilising high quality materials and components
- **Pre-hung Doorsets** - our doors are supplied as fully finished units, pre-hung in their frames with all essential components (ironmongery, glazing systems, seals etc fitted at works) from a single source, ensuring full compliance
- **Committed to Sustainability** - Ahmarra are FSC® certified (FSC C018847), and as such, all of our doors and frames support responsible forestry
- **One Stop Shop** - covering compatible architectural ironmongery, glazed screens, skirting boards, architraves, and paneling
- **Sound Advice** - our experienced specification and commercial team are always on hand to offer advice to Trusts, architects and contractors matching products with budgets
- **Installation** - doors can be supplied on a supply only or supply & fit basis. Our experienced installation team can provide a certified Q-Mark Fire Door Installation service, ensuring doors are fitted correctly and perform as intended

### Why Choose Our Healthcare Door Range?

- BM TRADA Q-Mark Timber Fire Door Manufacture scheme certified
- Anti-bacterial facings available (kills 99.9% of bacteria)
- Enhanced durability and impact resistance
- Replacement parts list available for Facilities Management teams to maximise the product's lifespan and retain certification
- Wide range of PVC, high pressure laminates and veneer finishes available
- Manufactured in Great Britain
- CPD sessions available







# Door Configurations

Our standard doorset design configurations are detailed below. They are available as single or double action, latched or unlatched and with or without vision panels. Glazing above doorsets (fanlights) is available above all door configurations - single doorset (S), unequal pair doorset (UP) and equal pair doorset (EP).

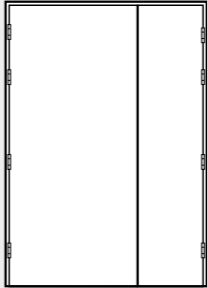
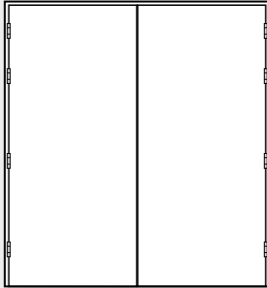
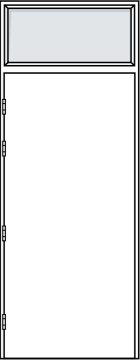
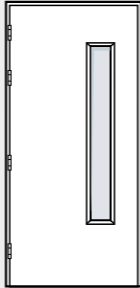
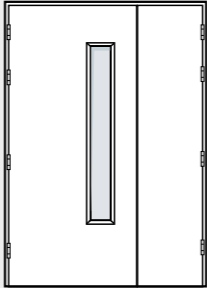
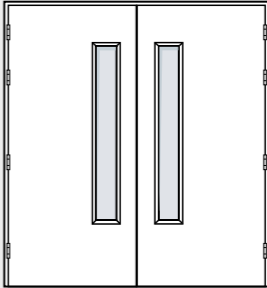
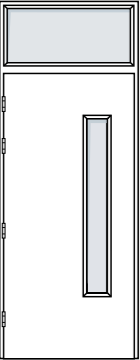
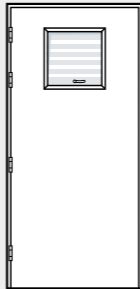
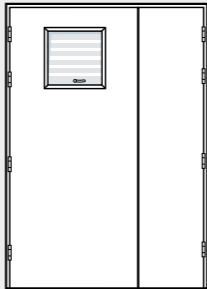
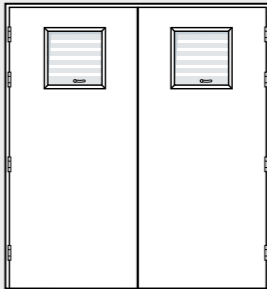
If you would like a pdf or dwg file of these door configurations, please email; [sales@ahmarra.co.uk](mailto:sales@ahmarra.co.uk)

<p><b>Single Doorset</b> Code: S</p> 	<p><b>Unequal Pair Doorset</b> Code: UP</p> 	<p><b>Equal Pair Doorset</b> Code: EP</p> 	<p><b>Single Doorset with Fanlight</b> Code: S-FL</p> 
<p><b>Single Doorset with Standard Vision Panel</b> Code: S-VP01</p> 	<p><b>Unequal Pair Doorset with Standard Vision Panel</b> Code: UP-VP01</p> 	<p><b>Equal Pair Doorset with Standard Vision Panel</b> Code: EP-VP01</p> 	<p><b>Single Doorset with Standard Vision Panel &amp; Fanlight</b> Code: S-VP01-FL</p> 
<p><b>Single Doorset with Privacy Vision Panel</b> Code: S-PV</p> 	<p><b>Unequal Pair Doorset with Privacy Vision Panel</b> Code: UP-PV</p> 	<p><b>Equal Pair Doorset with Privacy Vision Panel</b> Code: EP-PV</p> 	<p><b>Single Doorset with Privacy Vision Panel &amp; Fanlight</b> Code: S-PV-FL</p> 

# Facings & Finishes

The healthcare door range is available with anti-bacterial, impact resistant PVC-u or high pressure laminate facings, that support a modern hospital's infection control strategy. It is also available with wood veneers.

## PVC-U Facings

The 2mm impact resistant PVC-u range is available in 15 standard colours in a textured finish, offering a choice of contrasting, co-ordinating and harmonising solutions. The sheets can be applied to doors, door edges and glazing beads, kick plates, frames, stops and architrave.

These hygienic PVC-U door facings include an anti-bacterial additive that is integrated within the sheet material construction, causing 99.9% of bacteria to die within 24 hours. More colour options are available on request, as well as volatile organic compounds (VOC) free options at a premium.

<b>Polar White</b> RAL 9003 • LRV 84.02	<b>ivory</b> RAL 1013 • LRV 73.85	<b>Pale Grey</b> RAL 7044 • LRV 51.38	<b>Snow White</b> RAL 9001 • LRV 73.07
<b>Sand</b> RAL 1014 • LRV 60.08	<b>Pale Green</b> RAL 6034 • LRV 37.32	<b>Slate Grey</b> RAL 7011 • LRV 13.09	<b>Poseidon Blue</b> RAL 5012 • LRV 27.13
<b>Olive Green</b> LRV 18.34	<b>Pale Blue</b> RAL 5024 • LRV 31.03	<b>Twilight Blue</b> RAL 5003 • LRV 8.25	<b>Steel Grey</b> RAL 7038 • LRV 39.59
<b>Storm Grey</b> RAL 7037 • LRV 21.66	<b>Misty Grey</b> RAL 7046 • LRV 12.55	<b>Light Beige</b> LRV 44.85	

## High Pressure Laminates

The high pressure laminate range is available in a range of colours. These hygienic high pressure laminate door facings include an anti-bacterial additive that is integrated within the sheet material construction, causing 99.9% of bacteria to die within 24 hours. For the full range of Polyrey door laminate finishes, scan the QR code or visit: <https://ahmarra.co.uk/resource-centre/brochures/>

Laminates from other suppliers, such as Formica, are also available.

<b>Blanc Artic</b> B117 FA • LRV 86.0	<b>Orgeat</b> 0111 FA • LRV 79.0	<b>Blanco Especial</b> 030 • LRV 83.0	<b>Gris Tourerelle</b> G029 FA • LRV 55.0
<b>Gris Dauphin</b> G044 • LRV 55.0	<b>Gris Perle</b> G003 FA • LRV 40.0	<b>Beige Nature</b> B116 FA • LRV 51.0	<b>Gris Cendré</b> GO75 FA • LRV 32.0
<b>Gris Acier</b> GO76 • LRV 15.0	<b>Gris Orage</b> G059 FA • LRV 9.0	<b>Bleu Oslo</b> B048 FA • LRV 52.0	<b>Vert de Gris</b> V106 FA • LRV 40.0
<b>Cèdre Bleu</b> C118 FA • LRV 27.0	<b>Bleu Note</b> B198 FA • LRV 18.0	<b>Bleu Velvet</b> B196 FA • LRV 13.0	



## Wood Veneers

Wood veneers, as opposed to solid wood, provide a perfect uniform finish - free from knots, splits and staining.

Our most popular wood veneer door facings are below.

For more options, view our 'Decorative Facings and Finishes' brochure. Scan the QR code or visit: <https://ahmarra.co.uk/resource-centre/brochures/>



<b>American Cherry</b> Crown Cut • Average LRV 23.8	<b>American Cherry</b> Quarter Cut • Average LRV 23.4	<b>American White Oak</b> Crown Cut • Average LRV 31.8	<b>American White Oak</b> Quarter Cut • Average LRV 35.4
<b>Ash</b> Crown Cut • Average LRV 51.5	<b>Ash</b> Quarter Cut • Average LRV 55.9	<b>Steamed Beech</b> Crown Cut • Average LRV 35.8	<b>Steamed Beech</b> Quarter Cut • Average LRV 36.0
<b>Maple</b> Crown Cut • Average LRV 54.3	<b>Maple</b> Quarter Cut • Average LRV 57.7	<b>American Walnut</b> Crown Cut • Average LRV 14.7	<b>American Walnut</b> Quarter Cut • Average LRV 16.9

# Door Face Protection Plates

Ahmarra offer kick plates, mid-rail plates and half height plates in PVC or stainless steel that can either match or contrast with the door facing. All protection plates are pre-fitted at our manufacturing facility.

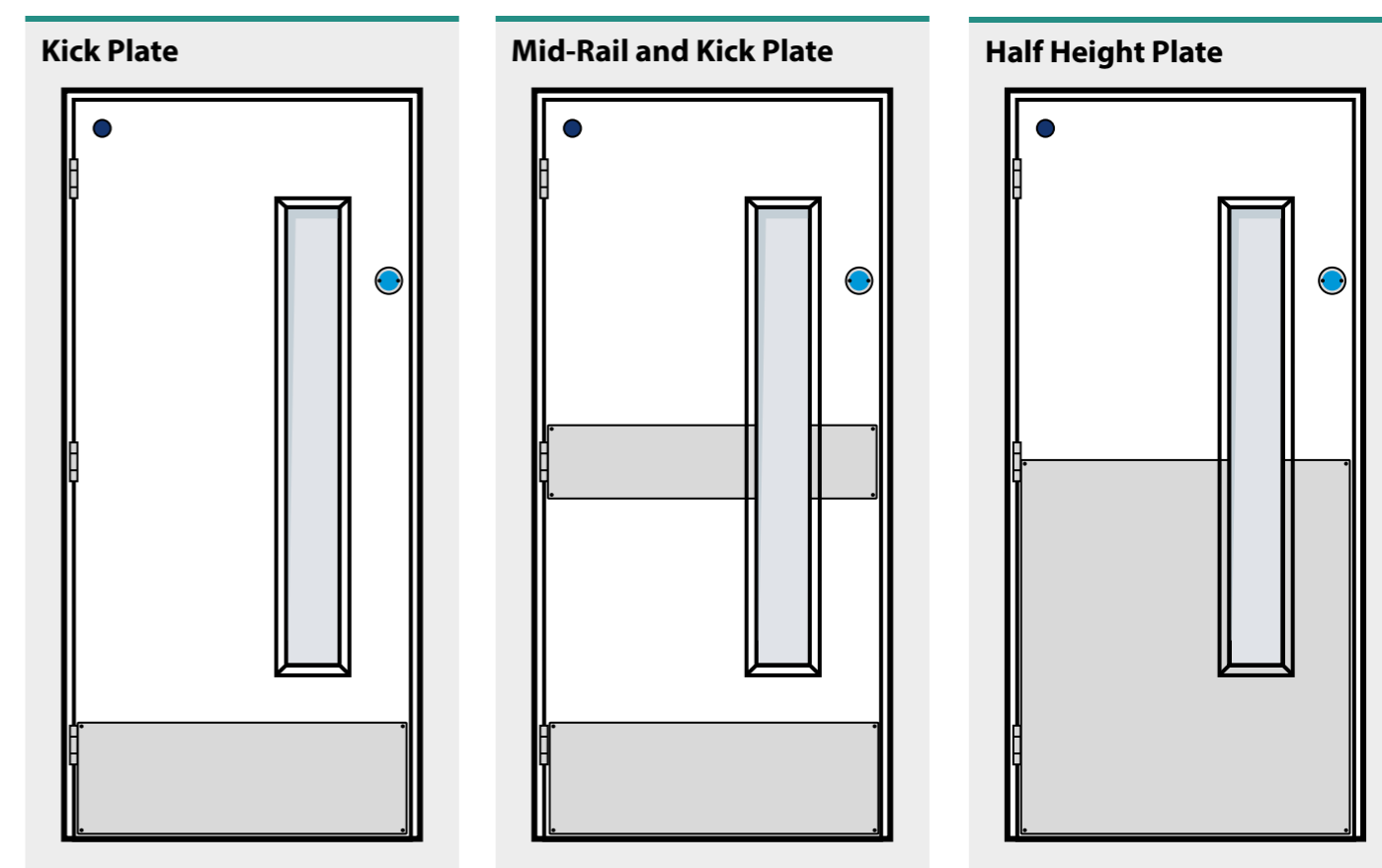

# Infection Control

To help safeguard patients, staff and visitors from hospital-acquired infection and promote a sanitary environment, Ahmarra's healthcare door range can be faced with either textured PVC-u or high pressure laminate (HPL). These facings feature an anti-bacterial additive that is integrated during the manufacturing process.

This additive prevents the bacteria from getting the nutrients they need, causing 99.9% of bacteria to die within 24 hours - combating the spread of harmful bacteria such as C-difficile, MRSA, Salmonella, Listeria and E.coli.

As well as door faces, door edges and glazing beads can also be clad in PVC impact resistant material. Ahmarra even have secret-fix PVC clad frames, stops, architrave and kick plates to complement the door which can be specified to match or contrast with the door leaf.

## Anti-bacterial Protection Sheet Features

Feature	2mm Impact Resistant PVC-U	Polyrey High Pressure Laminate
<b>Hygiene</b> Contains an anti-bacterial properties that kills 99% of bacteria within 24 hours. Surface is easy to keep clean with standard cleaning and disinfectant products.	Yes Contains Hygienilac®	Yes Contains Sanitized®
<b>Durability</b> Impact and scratch resistant - suitable for high-traffic areas.	Yes	Yes
<b>Humidity Resistance</b> Water-repellent material - prevents growth of mould and bacteria.	Yes	Yes
<b>Design</b> Available in a wide range of colours, which can be used to achieve the necessary LRV contrast against critical surfaces, assisting visually impaired staff and patients to navigate the building.	Yes	Yes
<b>Reduces Maintenance Costs</b> The durable protection sheets reduce maintenance costs by protecting vulnerable doors and walls from damage.	Yes	Yes
<b>Accessories</b> Colour matched silicone and adhesive to suit application.	Yes	Yes

## Independent Laboratory Results

Results from an independent microbiological laboratory are below:

Feature	2mm Impact Resistant PVC-U	Polyrey High Pressure Laminate
Escherichia coli	Yes	Yes
Klebsiella pneumoniae	Yes	Yes
Methycillin resistant staphylococcus aureus (MRSA)	Yes	Yes
Salmonella enteridis	Yes	Yes
Straphylococcus aureus	Yes	Yes
Aspergillus niger	Yes	No
Bacillus cereus	Yes	No
Clostridium difficile	Yes	No
Penicillium purpurogenum	Yes	No
Listeria monocytogenes	No	Yes

# Vision Panels

Ahmarra's healthcare door range has two standard vision panels. Other vision panel sizes and configurations are available on request, providing the glazed area complies with our fire certification.

According to BS 8300-2:2018 the minimum zone of visibility should be between 500mm and 1500mm above floor level, with a maximum interruption of 350 mm vertically within the zone. Our standard vision panel styles are Equality Act compliant to BS 8300-2:2018.

If you would like a pdf or dwg file of these vision panel and glazing bead illustrations, please email: [sales@ahmarra.co.uk](mailto:sales@ahmarra.co.uk)

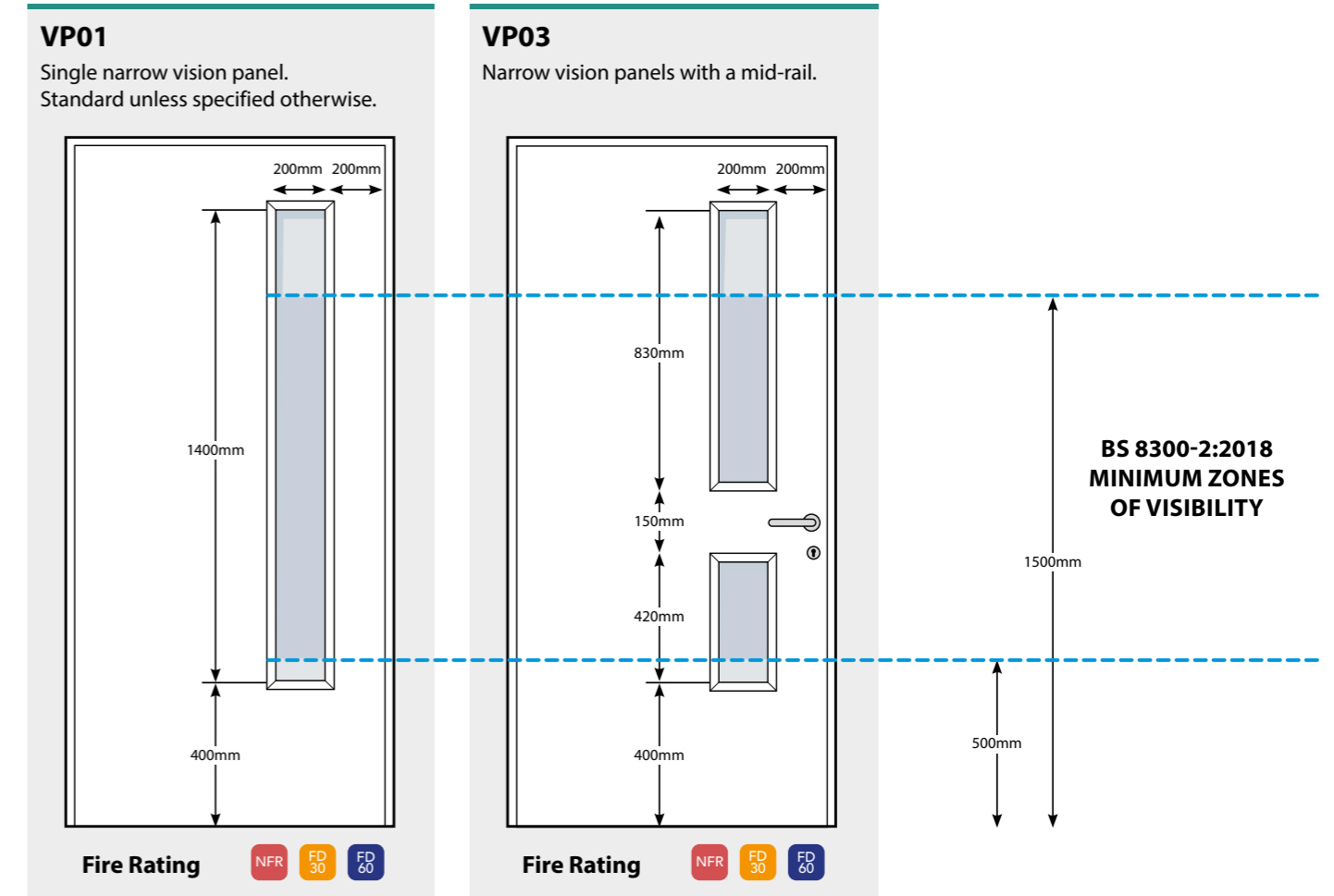

# Glazing Beads

Ahmarra's healthcare door range offers hardwood bolection, hardwood flush, PVC wrapped and stainless steel clad beading options. The PVC creates a seamless, vacuum sealed beading with no joints, for optimum infection control.

Hardwood Bolection	Hardwood Flush	PVC Wrapped	Stainless Steel Clad
Hardwood bolection beading (aka cloak bead) is suitable for PVC, laminate, wood veneer and primed doorsets.	Hardwood flush beading (aka quirk bead) is suitable for veneer and primed doorsets.	PVC wrapped beading is suitable for PVC and laminate doorsets.	Stainless steel clad beading is suitable for PVC, laminate, wood veneer and primed doorsets.

# Fire & Smoke Ratings

## Fire Rated Doors

Protecting vulnerable patients, many of whom will be incapacitated, is paramount during a fire outbreak. Fire doors form an essential part of a building's passive fire protection strategy, preventing the passage of fire and smoke from one compartment to another. Doorsets that meet the specified fire performance maximise the time staff have to help with safe evacuation of patients and provide sufficient time for fire-fighters to prevent the loss of expensive buildings and equipment. Hospital fire doors may therefore require a higher fire-rating than the standard FD30 (30 minutes burn time), such as FD60 (60 minutes burn time), FD90 (90 minutes burn time) or FD120 (120 minutes burn time). These times represent the time a door is anticipated and tested to withstand a fully engulfed fire situation.

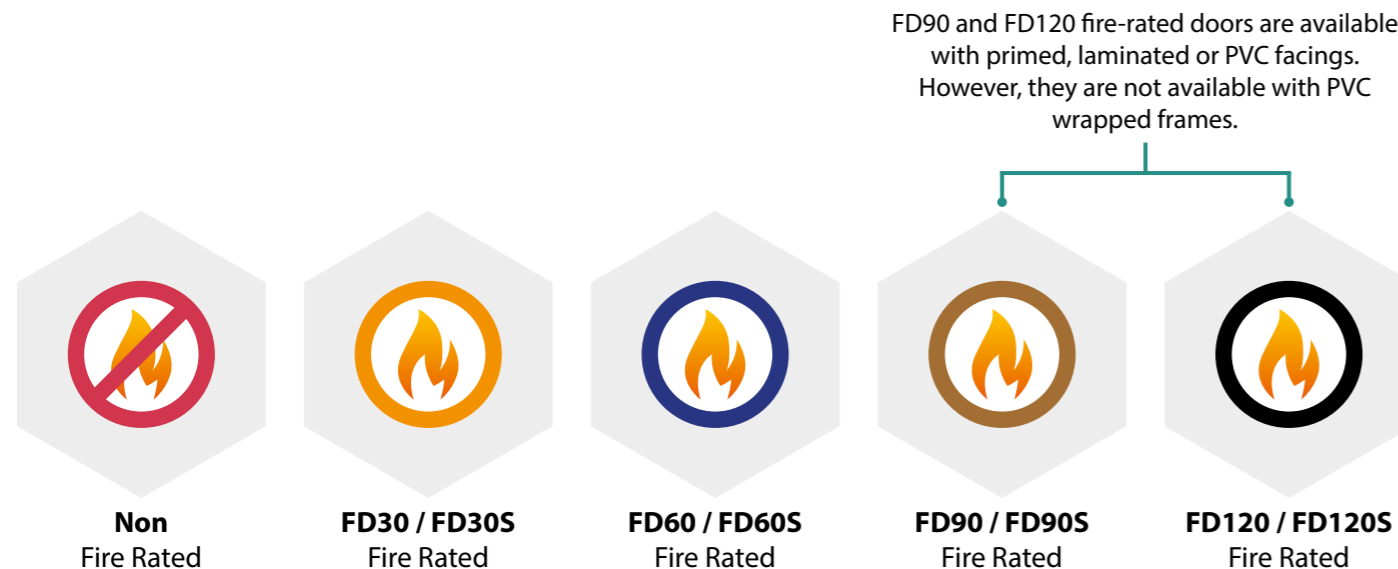

## Smoke Doors

While fire doors are designed to resist the passage of fire, it's important to note that 60% of fatalities occur due to smoke inhalation. Smoke can fill a room incredibly quickly and find its way out through the tiniest of gaps around the perimeter of the door.

Fire doors which also require smoke protection, are designated FD30S, FD60S, FD90S and FD120S. Some smoke seals can also have a dual purpose of keeping out drafts, reducing noise and providing a quiet close.

There are three main types of edge seals capable of providing the specified smoke leakage rates;

- 1) **Deflection or compression seals**, normally fitted to the doorstop to produce contact with the face of the door.
- 2) **Brush or wiping seals** fitted in the leaf edge or in the frame opposite the edge, or at the threshold at the bottom of the door.
- 3) **Combined fire and smoke seals** incorporate intumescent material with a smoke seal and allow for one product to be fitted to perform both fire and smoke protection functions.

Types 1 and 2 are often used in conjunction with intumescent seals to achieve both fire and smoke resistance.

## Q-Mark Fire Door Manufacture

Fire door manufacturers must provide evidence that their doors meet the specified safety standards. However, it is still legal for fire door manufacturers in the UK to self-certify. The best way to ensure that the doors meet the critical standards you require, is to specify that both the manufacturer and installer have independent, third-party certification.

Ahmarra are a certified member of the BM TRADA Q-Mark Timber Fire Door Manufacture and Q-Mark Fire Door Installation schemes. BM TRADA are one of the UK's leading providers of independent certification and are a widely accepted quality standard. Every one of our timber fire doorsets is produced and installed to the same specification approved by BM TRADA.

Third-party certification means that the manufacturer/installer has undergone a rigorous audit and testing process conducted by an impartial specialist body. This involves having documented product specifications, installation instructions and controlled factory production processes.

## Primary Fire Door Testing

We have invested in our own fire testing for the FD60 hospital doorsets. This product includes full PVC impact protection plates and replaceable wrap-around PVC edge protection on both the hanging and leading edges. This door has been tested in what is considered to be one of the most onerous scenarios i.e. FD60, glazed, unequal pair, opening towards the fire attack direction.

# Acoustic Ratings

## Acoustic Rated Doors

In a busy healthcare environment that operates 24/7, internal acoustic doors play a vital part in preventing noise passing from one area to another, improving the patient experience and creating an environment that supports a restful recovery. Acoustic-rated doors have been designed to provide a specific level of noise reduction, be that for patient confidentiality outside consulting rooms for example, or to reduce noise from corridors on single bed wards. Sound resistance is achieved through a combination of specifically engineered door cores and sealing arrangements.

Ahmarra's Q-Mark certified Healthcare Range is available with 32 RwdB or 35 RwdB acoustic-ratings, or as non-acoustic rated. Performances up to 43 RwdB are available for high pressure laminate and veneered doors upon request.

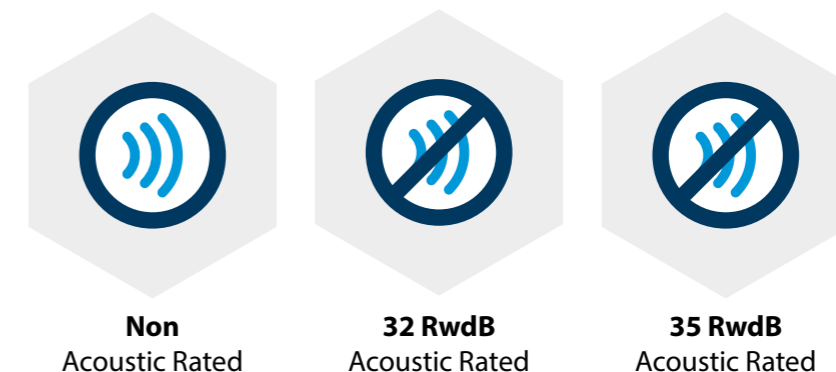

The Department of Health's 'Health Technical Memorandum 08-01: Acoustics' gives comprehensive advice and guidance on the design, installation and operation of specialised building and engineering technology used in the delivery of healthcare. Its guidance on internal sound insulation, with regard to doors, acoustics states that;

2.75 Solid-core door blanks (minimum 21 kg/m<sup>2</sup>) should be used for access from corridors, and these are capable of achieving an acoustic performance in the range Rw 30–35 dB. If seals can be accommodated, the entire doorset is capable of achieving this level of sound insulation. If seals are not to be provided, the overall performance of the doorset will be in the range Rw 20–25 dB.

# Door Frame Types & Drawings

If you would like a pdf or dwg file of these frame drawings, please email; [sales@ahmarra.co.uk](mailto:sales@ahmarra.co.uk)

## PVC Frame and Door Sections: Single Action Frame

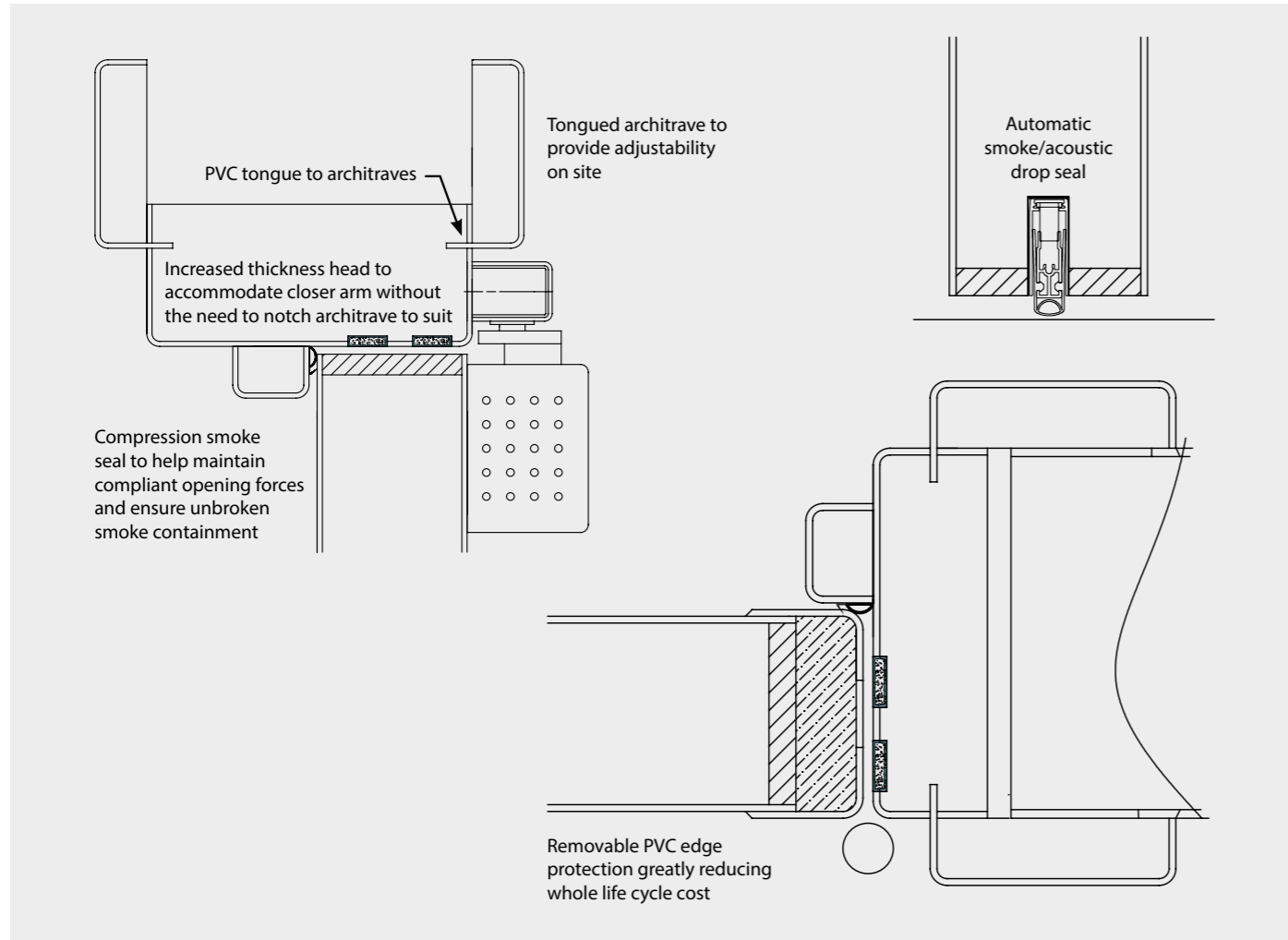

## PVC Frame and Door Sections: Double Action

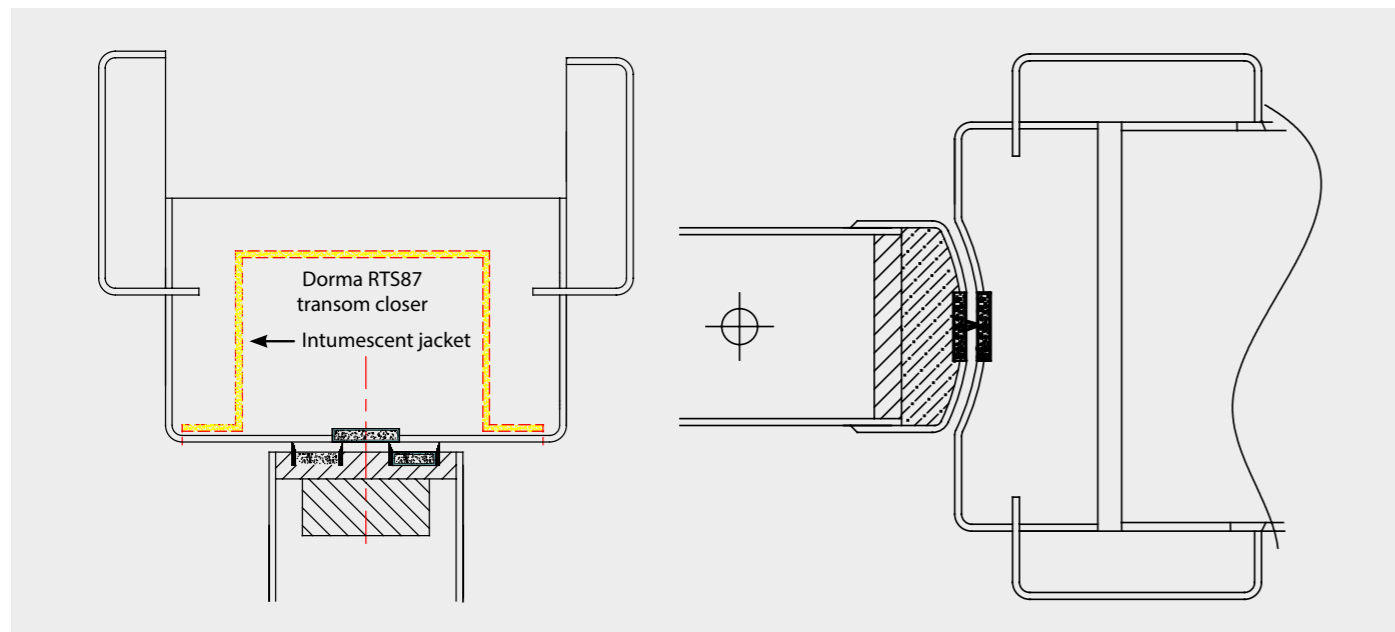

## Timber Frame and Door Sections with Plain Lining: Single Action

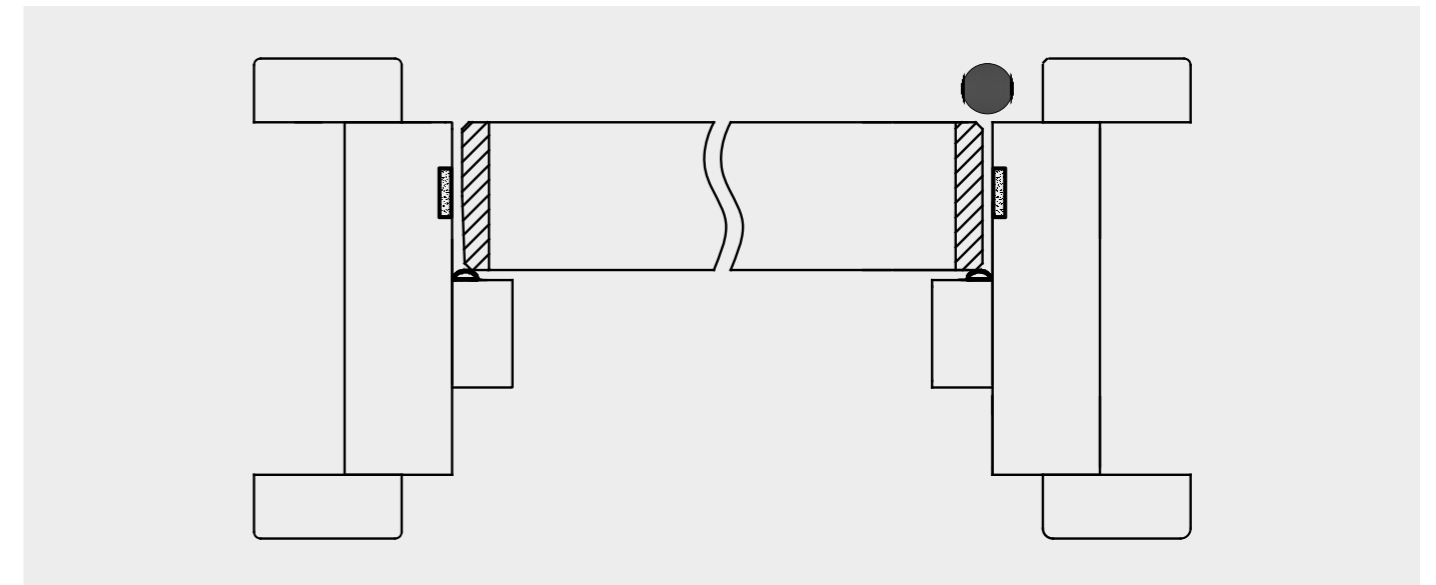

## Timber Frame and Door Sections with Plain Lining: Double Action

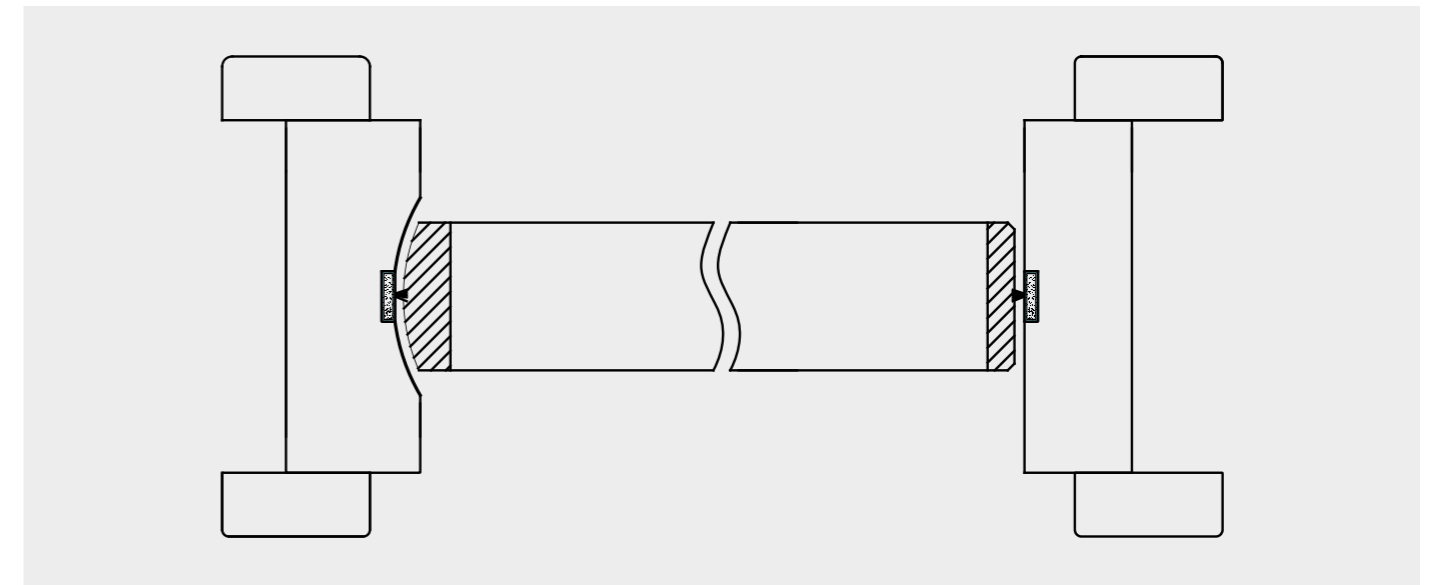









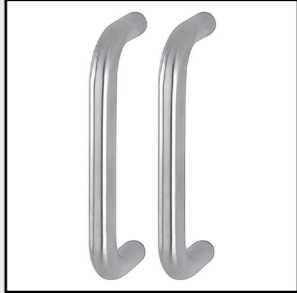

# Architectural Ironmongery

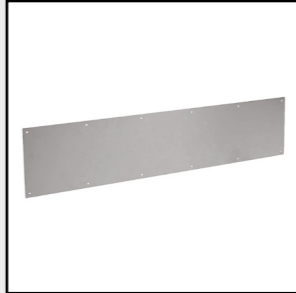
Ahmarra offers a complete architectural ironmongery service to compliment your choice of doorset. Our ironmongery range includes fully compatible, fire-rated door handles, hinges, locks, closers, signage, protection plates, escutcheons, flush bolts, door stops, turn & releases and pivots. The range is available in a wide range of styles and finishes.

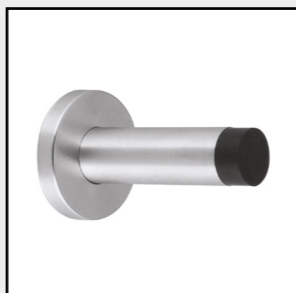
Ahmarra are a full member of the Guild of Architectural Ironmongers (GAI). Our in-house Architectural Ironmongery Manager, Ian Heafield (DipGAI & DipFD), manages the supply and project scheduling of coordinated architectural ironmongery for our bespoke doorsets. And, alongside our specification team, he is on hand to provide you with technical advice and support on the most suitable components for your project.

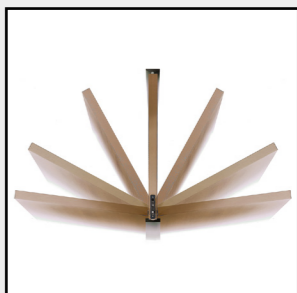
<b>Locks</b> 	<b>Hinges</b> 	<b>Lever Handles</b> 	<b>Pull Handles</b> 
<b>Closers</b> 	<b>Signage</b> 	<b>Protection Plates</b> 	<b>Escutcheons</b> 
<b>Flush Bolts</b> 	<b>Door Stops</b> 	<b>Turn &amp; Releases</b> 	<b>Pivot Sets</b> 

## Replacement Parts

Our durable healthcare door range has been specifically designed for longevity, whilst allowing for replacement of elements that may get damaged over the years, including replaceable hanging and leading edge protection. Ahmarra can supply a replacement parts list for Facilities Management teams, so that they can source like-for-like parts directly from the suppliers that manufactured the originals. This will maximise the lifespan of the doors, whilst retaining certification.

Fire doors should be inspected every 3, 6 or 12 months, depending on their location and level of usage, and maintained accordingly to ensure the product continues to perform as intended.

# Hold Open Options

## Hold Open Devices for Doors

Ahmarra offer electro-magnetic hold open closers/floor springs and transom closers for doors. All have adjustable closing and latching speeds, as well as free swing options available.

These electromagnetic products eliminate the need for wall mounted hold open devices.

### TS92EMF: Single Action Electromagnetic Hold Open Closer

#### Features

- Cam action door closer with slide arm
- Adjustable closing force
- Adjustable closing and latching speed

#### EN1155 Classification

1	2	3	4	5	6
4	8	1-4	1	1	3

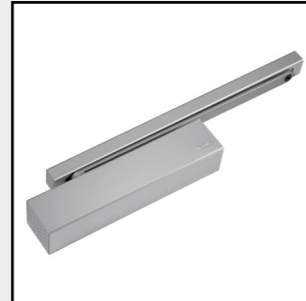

#### Technical Details

Closing Force	EN1-4
Max. Door Width	1100mm
Body Size	281 x 65 x 47mm
CE Marked	to BS EN 1154
Maximum Opening Angle	180°
Voltage	24 V DC± 15%

### BTS80EMB: Double Action Floor Spring

#### Features

- Electromagnetic hold open from 85° to 175°
- Adjustable closing and latching speed
- Available for doors up to 1400mm
- Free swing option available

#### EN1155 Classification

1	2	3	4	5	6
3	8	4	1	1	4

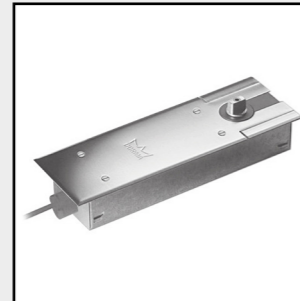

#### Technical Details

Closing Force	EN4
Max. Door Width	1100mm
Body Size	341 x 78 x 60mm
CE Marked	to BS EN 1155
Maximum Opening Angle	175°
Voltage	24 V DC± 15%

### RTS80EMB: Hold Open Transom Closer

#### Features

- Electromagnetic hold open from 75° to 175°
- Adjustable closing and latching speed
- Mechanical backcheck

#### EN4 Classification

	1	2	3	4	5	6
EN1154	3	8	4	1	1	4
EN1155	3	8	4	1	1	4

#### EN5 Classification

	1	2	3	4	5	6
EN1154	3	8	5	1	1	4
EN1155	3	8	5	1	1	4

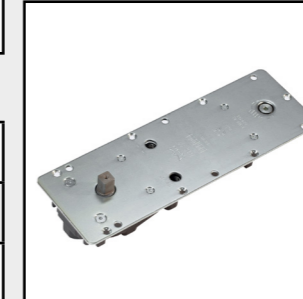

#### Technical Details

Closing Force	EN4 / EN5
Max. Door Width for EN4	1100mm
Max. Door Width for EN5	1250mm
Body Size	360 x 180 x 61mm
CE Marked	to BS EN 1155
Maximum Opening Angle	175°
Voltage	24 V DC± 15%

### TS99FL: Free-swing Slide Channel Door Closer in Contur Design

#### Features

- Hold-open device with a free-swing function from a door opening angle of > 0°, which, combined with a smoke detector system (e.g. RMZ), that can be used as a hold-open system for fire doors.
- Adjustable closing and latching speed
- Meets legal requirements for barrier-free building

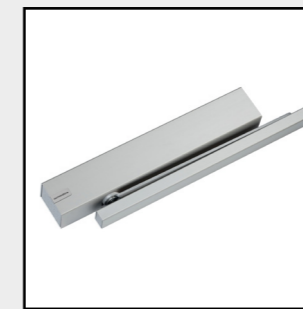

#### Technical Details

Closing Force	EN2-5
Max. Door Width	1250mm
Body Size	413 x 71 x 52mm
CE Marked	to BS EN 1154
Maximum Opening Angle	150°
Voltage	24 V DC± 15%

#### EN1154 Classification

1	2	3	4	5	6
3	8	4	1	1	3

#### EN1155 Classification

1	2	3	4	5	6
3	8	5	1	1	3



# Vistamatic Privacy Vision Panels

Ahmarra offer privacy vision panels within the healthcare door range.

The triple glazed system features a large viewing aspect and full length, evenly spaced, alternating lines. This allows for discreet and secure observation, whilst having the appearance of contemporary Venetian blinds.

Blinds are operated using the Vistamatic proprietary lever mechanism. When the lever is turned, the inner sheet of glass rises to enable observation and, by turning the handle back, vision is obscured.

Ahmarra would need to know if the lever operation is required on the inside or outside of the room, or on both.

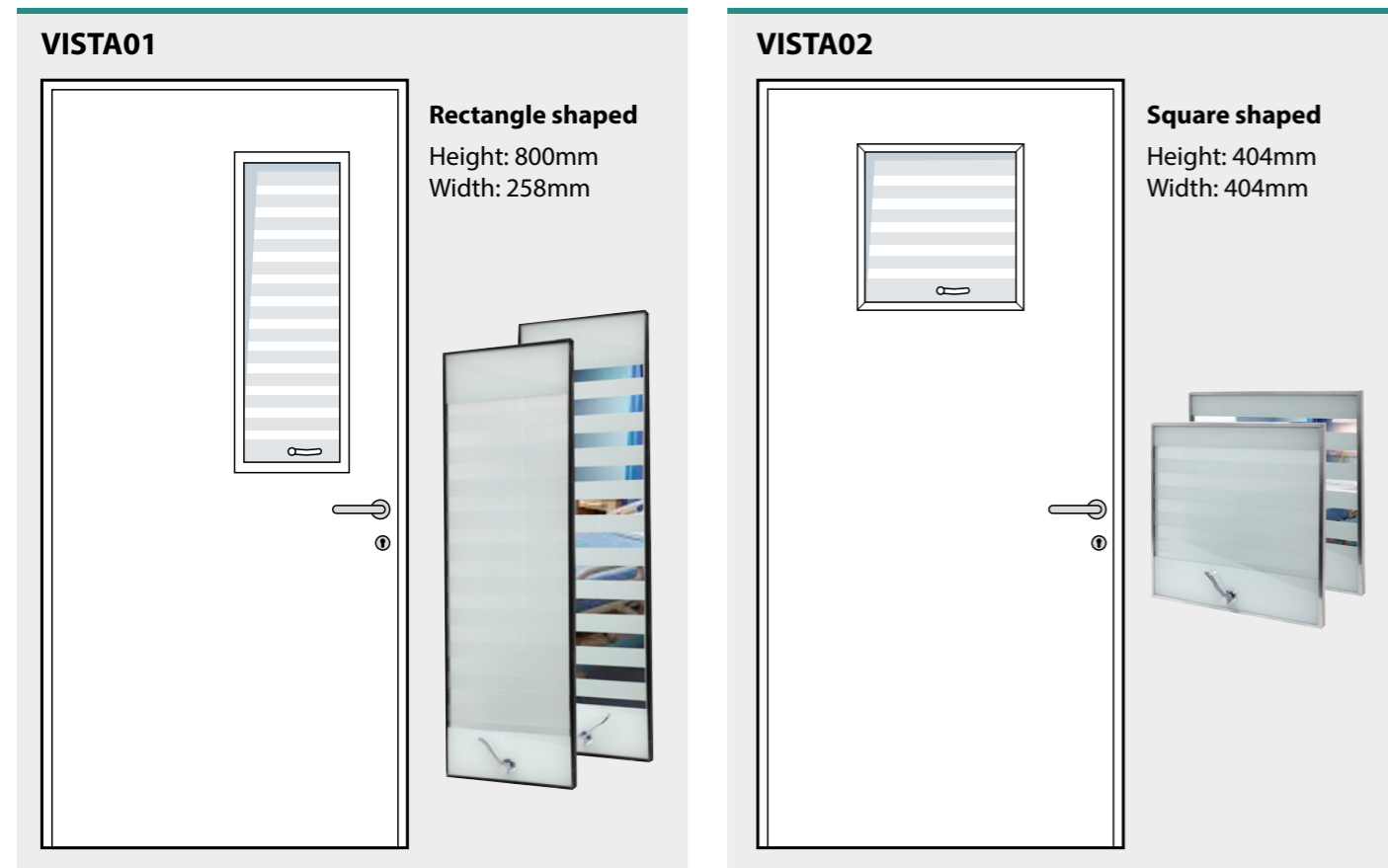

# Door Cores

## Severecore

Ahmarra's healthcare door range is made with Severecore™ blanks. Severecore™ is a solid three layer particle board that achieves severe-duty durability under the classification standard BS EN 12400:2002. Built to last, the door blanks are lipped on all four edges for extra durability.

Our timber door cores are made from FSC®-certified and other controlled materials, which supports responsible forestry. Additional modifications are made to our cores to suit double action doors. Ahmarra will also utilise alternative core constructions where performance requires, such as enhanced acoustic or fire rating.



## Why Specify Severecore™?

- High Performance**  
 The engineered performance has been tested to achieve a severe duty rating for durability.
- Flexibility in Design**  
 Certification covers a wide range of door sizes, fire ratings, glazing and acoustic options.
- Engineered Timber**  
 This ensures that the materials within the door construction are defect free.
- Environmentally Friendly**  
 Made from sustainable materials.

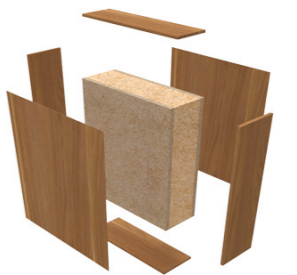

## Technical Details

### FD30 Specifications

Weight: 27.3 kg m<sup>2</sup>  
 Width: 44mm  
 U-Value (W/km<sup>2</sup>): 2.0

### FD60 Specifications

Weight: 33.5 kg m<sup>2</sup>  
 Width: 54mm  
 U-Value (W/km<sup>2</sup>): 1.8

Summary of Testing Procedure	Result
BS EN 947, EN948, EN949 and EN950 (classified to BS EN 1192 mechanical strength)	Severe Duty, Class 4
BS EN1191 (classified to BS EN 12400 mechanical durability)	Severe Duty, Class 8, Completed 1,000,000 Cycles



Based in Hampshire, Ahmarra have been manufacturing doors for over 30 years.

We are proud to fly the flag for British manufacturing and use traditional craftsmanship, cutting edge technology and the finest materials to guarantee exceptional standards.

